

EVO
CABINA E PIANO
CAR AND LANDINGS





BLUE
B34SMA - A42SMA

ESSENZIALITÀ E VERSATILITÀ

Sono i tratti distintivi della cabina Evo. Le linee pulite degli angoli e del tetto esaltano il contrasto cromatico tra le pareti laterali e la parete di fondo, personalizzabili a piacere anche nei materiali. Principale elemento caratterizzante è la pulsantiera, disponibile nella versione "link" a placca o "flush" a colonna.

DIMENSIONI

LARGHEZZA: 600 - 2000 mm
PROFONDITÀ: 500 - 2100 mm
PORTATA: 225 < 1000 Kg

ALTEZZA:

- 2110 mm (Standard)
- 2210 mm (Rialzata)
- 2005 mm (Ribassata)

ACCESSI: 1, 2 o 3

SIMPLICITY AND VERSATILITY

These are the distinctive features of the Evo car. The clean lines of the corners and of the roof enhance the contrast of colours between the side walls and the back wall, customizable also in the materials. The main distinctive feature is the push-button panel, available in the version "link" on a plate or "flush" column.

DIMENSIONS

WIDTH: 600 - 2000 mm
DEPTH: 500 - 2100 mm
RATED LOAD: 225 < 1000 Kg

HEIGHT:

- 2110 mm (Standard)
- 2210 mm (Higher)
- 2005 mm (Lower)

ENTRANCES: 1, 2 or 3



RED:
R24SMA - A42SMA



YELLOW :
G11SMA - A42SMA



SILVER
F41PPS - A42SMA

Le pareti laterali ed il cielo bianco mettono in risalto la parete di fondo, personalizzabile a piacere. Caratterizzata da linee pulite ed essenziali, accentuate dall'assenza di angoli e zoccoli, Evo lamiera plastificata è disponibile con bottoniera a placca "link" o colonna a tutta altezza "flush". *The side walls and white ceiling highlight the back wall, customizable to taste. Characterized by clean, essential lines, accentuated by the absence of corners and skirtings, Evo skinplate is available with a push-button panel on plate "link" or the column full height "flush".*

Note | Notes: La cabina può essere anche realizzata con le pareti laterali nei colori indicati nelle finiture (cielino sempre in A42SMA). *The car can be made with side walls with the colour as per finishings (ceiling always in A42SMA).*

FINITURE (parete di fondo, lato accessi e antine)
FINISHINGS (rear wall, entrance sides and door panels)



Simil Inox (F12PPS)

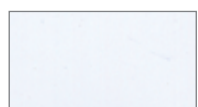

Bianco Lucido (A32PP)

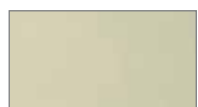

Bianco Panna (A42SMA)



Sabbia (A13)



Giallo Spring (G11SMA)



Blu (B34SMA)



Blu Notte (B41SMM)



Grigio Lucido (PPS1)

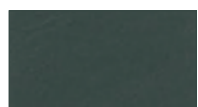

Grigio Tempesta (N4)



Simil Spazzolato (F41PPS)



Grigio Alluminio (F21SMA)



Rosso (R24SMA)

PARETI LATERALI E CIELINO
SIDE WALLS AND CEILING



Bianco Panna (A42SMA)

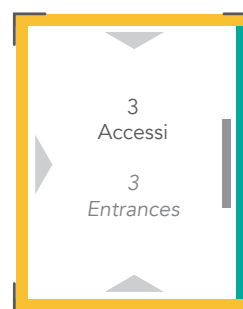
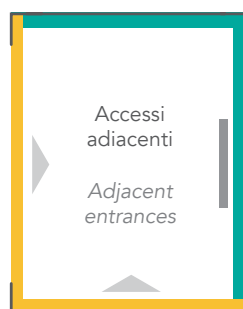
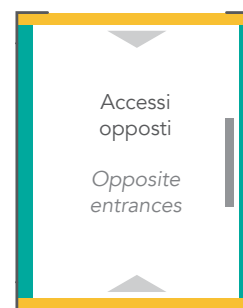
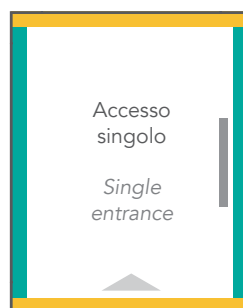
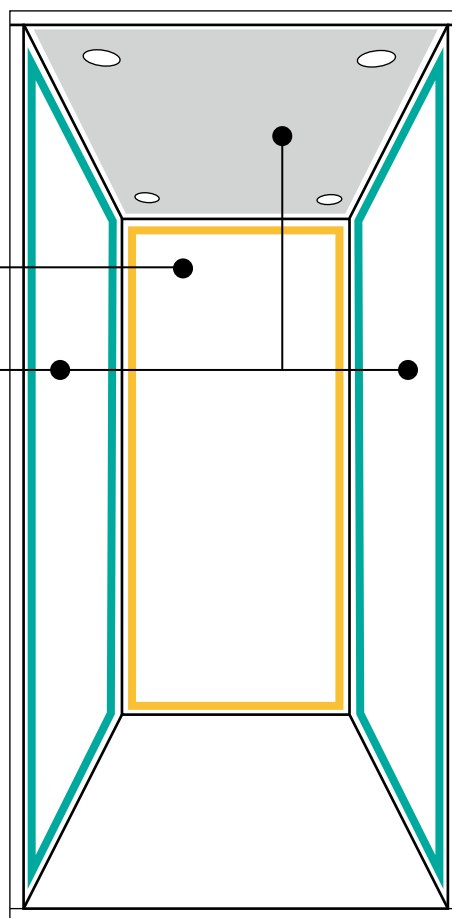



INOX SPAZZOLATO
BRUSHED STAINLESS STEEL

Un materiale pregiato come l'acciaio si presta particolarmente all'abbinamento di finiture a contrasto. Priva di angoli e zoccoli, Evo inox è disponibile con bottoniera a placca "link" o colonna a tutta altezza "flush".

A precious material like steel is particularly indicated for the combination of contrasting finishes. Without corners and baseboards, Evo stainless steel is available with a push-button panel on plate "link" or column full height "flush".

EVO

ACCIAIO INOX
STAINLESS STEEL

PARETI LATERALI* | SIDE WALLS*



Lucido
Shiny



Spazzolato
Brushed

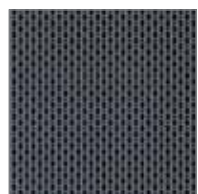

Lino lucido
Shiny linen pattern



Quadrettato lucido
Shiny square pattern

*Altri colori inox ed abbinamenti disponibili su richiesta
*Other stainless steel options available on request

FINITURE*
(parete di fondo, lato accessi, antine e cielino)
FINISHINGS*
(rear wall, entrances side, door panels, ceiling)



Lucido
Shiny



Spazzolato
Brushed

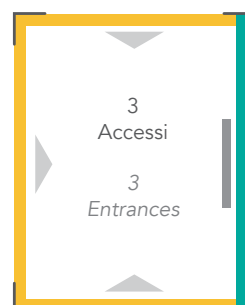
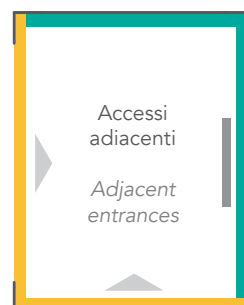
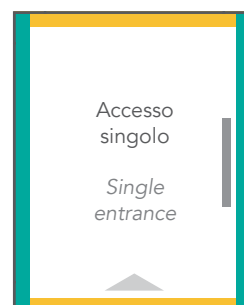
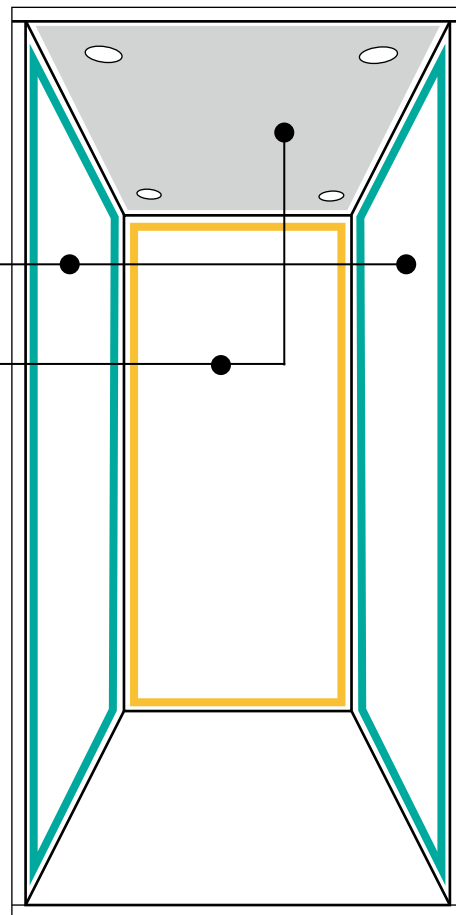

EVO

LAMINATO LAMINATE

L'ampia gamma di colori e di finiture disponibili stimola la fantasia nella creazione di abbinamenti personali, nuovi e mai scontati. Tratto caratterizzante della cabina è il contrasto cromatico tra la parete di fondo e le pareti laterali; tale contrasto è particolarmente evidenziato dagli spigoli laterali nudi. La scelta di realizzare tutte le pareti dello stesso colore è invece indicato per un effetto più tenue. Disponibile solo con colonna a tutta altezza "flush" e zoccolatura inferiore.

The wide range of colours and finishes available stimulates imagination when it comes to creating combinations that are personal, new and never predictable. The main feature of the car is the contrast of colours between the rear wall and the side walls; this contrast is particularly highlighted by the bare corners on the sides. Instead, the choice of having all the walls of the same colour is recommended for a more tenuous effect. Available only with the column-full height "flush" and lower skirtings.



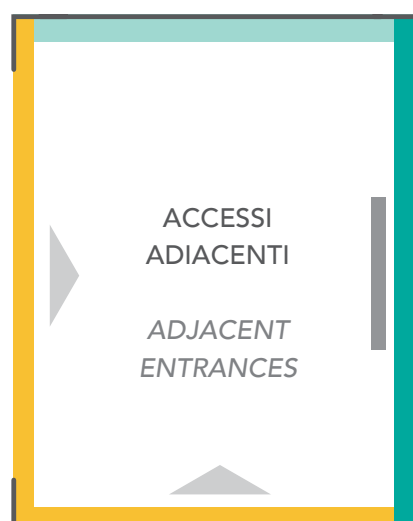
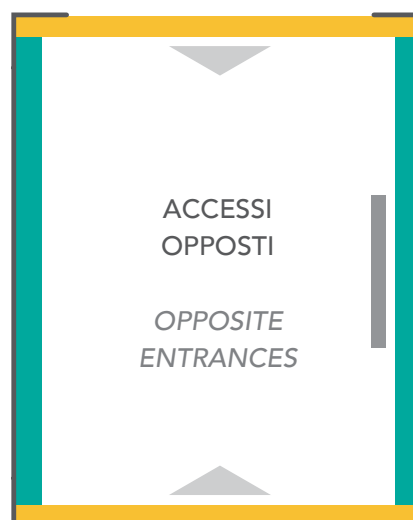

EVO Laminato | EVO Laminate
460 Fin. 6 - 602 Fin. Holz

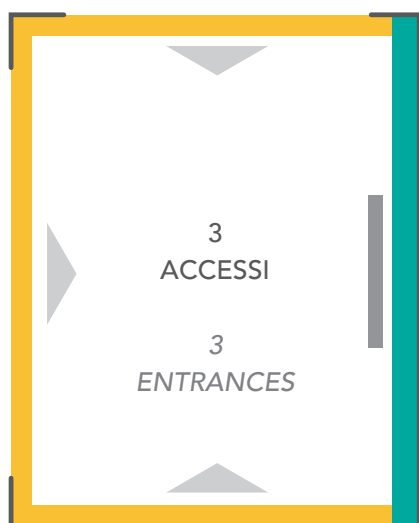

PARETI | WALLS



LEGENDA | LEGEND:

-  Parete di fondo
Main wall
-  Pareti a contrasto
Other walls
-  Finiture e cielino
Finishings and ceiling

LAMINATI STANDARD | STANDARD LAMINATES

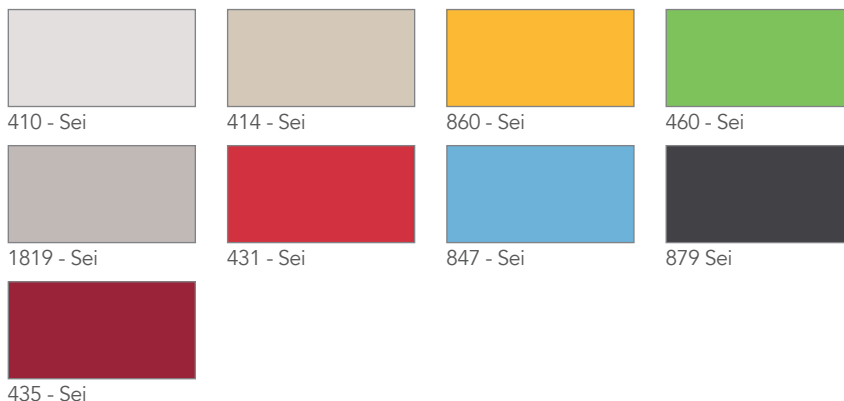

LAMINATI SPECIALI | SPECIAL LAMINATES

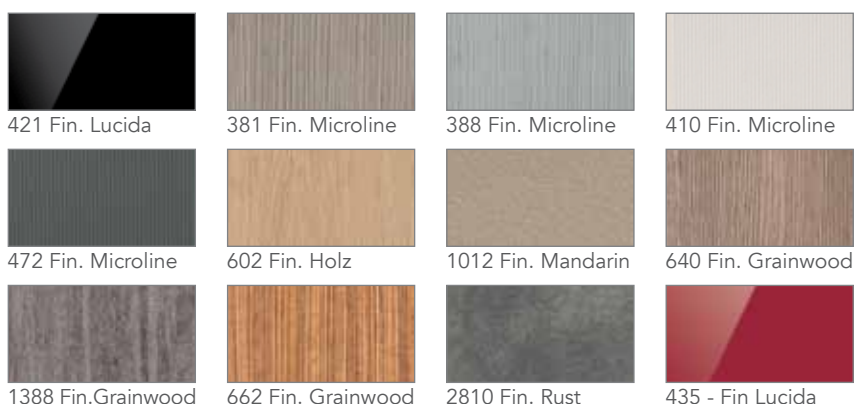

Note | Notes:

1. Per le pareti in laminato si può scegliere un unico colore, oppure due colori diversi come da schema a fianco;
 2. Nel caso di pareti di larghezza > 1300 mm, verrà inserito un doppio rompi tratta verticale dello stesso colore delle finiture.
- 1. For laminate walls you can choose only one colour, or two different colours according to the diagram on the left;*
- 2. In the case of walls with a width greater than 1300 mm, a double vertical break of the same colour of the finishes will be added.*

FINITURE* | FINISHINGS*

LAMIERA PLASTIFICATA | SKINPLATE



ACCIAIO INOX | STAINLESS STEEL

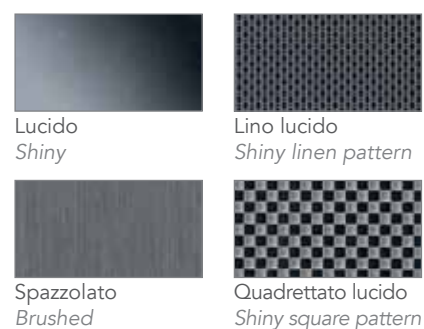

*Parete lato accessi, cielino, antine, zoccolatura inferiore.
*Wall on entrance side, ceiling, car doors, lower skirtings.



CONCRETE
410 Fin.6 - 2810 Fin. Rust - F41PPS



PULSANTIERE E SEGNALETICA CALL STATION AND SIGNALIZATION

12

LINEA ELLIPSE | ELLIPSE LOP

Linea morbida e profilo arrotondato.
Soft line and rounded profile.



Display grafico TFT con tema "Sele". Disponibile anche con display dot matrix rosso o blu.
TFT graphic display with "Sele" theme. Blue or red dot matrix displays are also available



Disponibili anche con illuminazione rossa, logo personalizzabile (b/n).
Red lighting is also available, customizable logo (b/w).

DISPLAY MINI DOTMATRIX

Con posizione e frecce direzionali
With car position and directional arrows



1. Disponibile anche con pulsantiera Plate e Ala.
2. Disponibile anche con display Dot Matrix rosso.
3. Possibilità di montaggio senza scassi a muro (solo con Ellipse)
 1. Also available with Plate or Ala LOP.
 2. Also available with red Dot Matrix display.
 3. Wall installation without break-in provision (only for Ellipse)

LINEA PLATE | PLATE LOP (STANDARD)

Linea elegante e profilo ultrasottile. *Elegant line and ultra-thin profile.*



Disponibili anche con illuminazione blu, logo personalizzabile (b/n).
Blue lighting is also available, customizable logo (b/w).



Display dot matrix rosso con posizione e frecce direzionali. Disponibile anche con display dot matrix blu o display grafico TFT.
Red dot matrix display with position indicators and direction arrows. Blue dot matrix display or TFT graphic display are also available.

LINEA ALA | ALA LOP (STANDARD)

Linea razionale e profilo geometrico | *Balanced line and geometric profile.*



Display dot matrix blu con frecce direzionali. Disponibile anche con display dot matrix rosso o display grafico TFT.
Blue dot matrix display with direction arrows. Red dot matrix display or TFT graphic display are also available.



Disponibili anche con illuminazione rossa.
Red lighting is also available.

PULSANTIERA DI CABINA | CAR COP

14



Bottoniera FLUSH | FLUSH pushbutton
Colonna a tutta altezza a filo con le pareti di cabina, abbinata alle finiture nelle cabine in laminato plastico e alle pareti laterali nelle cabine in lamiera plastificata o inox.
Disponibile per tutte le versioni.
Column full height along the walls of the cabin; it matches the finish of the cabin for EVO laminate; it matches to side walls for EVO skinplate or stainless steel.
Available with any EVO model.



Bottoniera LINK | LINK COP
Colonna a $\frac{3}{4}$ quarti. Disponibile in tutti i colori di lamiera plastificata è impreziosita da un bordo in acciaio grigio o nero.
Non disponibile su EVO Laminato.
3/4 column. Available in all the colours of skin-plate, embellished with a grey or black steel edge. Not available for EVO Laminate

PANNELLO BOTTONIERA

Tutti i colori delle lamiere plastificate indicate nelle finiture

PUSH-BUTTON PANEL

All the colours of skin-plate indicated in the finishes

PROFILO BORDATURA | EDGING PROFILE



Grigio | Gray
RAL 9007

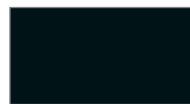

Nero | Black
RAL 9005

DISPLAY E PULSANTI DI CABINA | CAR DISPLAYS AND PUSHBUTTONS



Dot matrix rosso | Red dot matrix
(Standard)



Dot matrix blu | Blue dot matrix



Grafico TFT (tema 1 – Standard Sele)
TFT graphic (theme 1 – Sele Standard)



Grafico TFT (tema 2)
TFT graphic (theme 2)



Grafico TFT (tema 3)
TFT graphic (theme 3)



Grafico TFT (tema 4)
TFT graphic (theme 4)



Grafico TFT (tema 5)
TFT graphic (theme 5)



Scrolling frecce di direzione
Direction arrows scrolling

PULSANTI | PUSHBUTTONS



Tondo con illuminazione rossa o blu
Round pushbutton with red or blue lighting (Standard)



Quadrato con illuminazione rossa o blu
Square pushbutton with red or blue lighting (Standard)



Pulsante tondo dual light
Dual light round pushbutton



Ovale con illuminazione rossa o blu
Oval pushbutton with red or blue lighting

CIELINI | CEILINGS



FLUO (standard)
2 lampade fluorescenti compatte
2 fluorescent lamps with polycarbonate

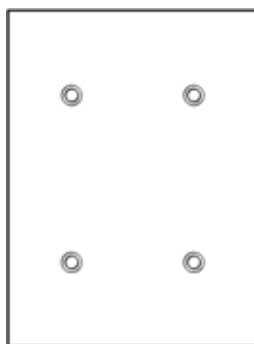

SLIM*
4 Faretto LED, ghiera cromata
4 LED spots with chrome ring

*Per cabina ribassata | For lower cabin

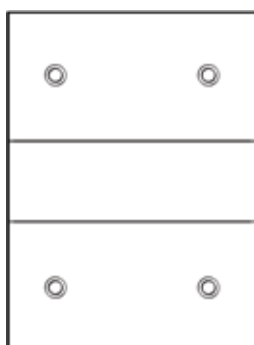

FARETTI
4 LED ghiera cromata
4 LED spots with chrome ring

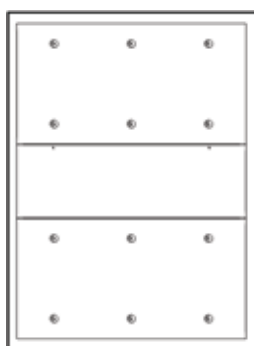

STELLATO
12 LED puntiformi
12 dot LEDs

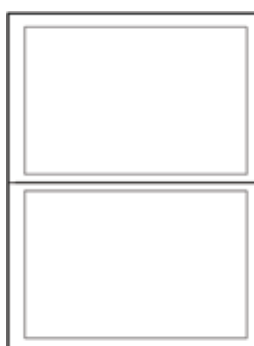

OPALE
Pannelli in policarbonato con 2 neon
2 fluorescent lamps with wide polycarbonate

PERSONALIZZAZIONI CUSTOMIZATIONS

CORRIMANO A PARETE | WALL HANDRAIL



Corrimano tondo raccordato in inox spazzolato o lucido
Round handrail connected via brushed or shiny stainless steel



Corrimano tondo dritto in inox spazzolato o lucido (EN81-70)
Straight brushed or shiny stainless steel round tube (EN81-70)



17

SPECCHI | MIRRORS

INTERA PARETE "T"

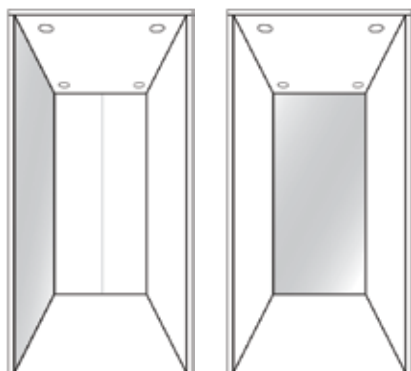

Parete laterale
Side wall

Parete frontale
Front wall

3/4 ALTEZZA

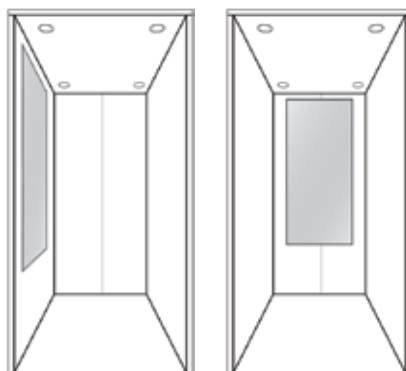

Parete laterale
Side wall

Parete frontale
Front wall

APPLICATO 1/2 ALTEZZA "AM"

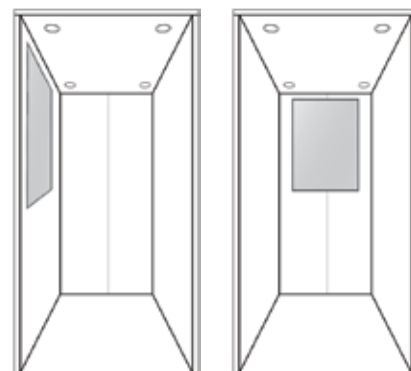

Parete laterale
Side wall

Parete frontale
Front wall

Note | Notes:

1. Lo specchio intera parete viene sempre fornito con la zoccolatura inferiore | The "T" mirror is always supplied with lower skirting.
2. Sullo specchio intera parete non è possibile applicare il corrimano | In case of "T" mirror the handrail on the same wall is not feasible.

PORTE AUTOMATICHE | AUTOMATIC DOORS

18



Lamiera plastificata
Skinplate



Acciaio inox
Stainless Steel

2 ANTE

Finiture:
- Vernice anticorrosiva RAL 7032 (standard)
- Verniciate RAL colore a scelta
- Lamiera plastificata
- Inox
Disponibili anche EN 81-58*

2 PANELS

Finishings:
- Anti-rust paint RAL 7032 (standard)
- RAL paint, colour on request
- Skinplate
- Stainless steel
Fire-resistant doors also available EN 81-58*



3 - 4 - 6 ANTE

Finiture:
- Vernice anticorrosiva RAL 7032 (standard)
- Verniciate RAL colore a scelta
- Lamiera plastificata*
- Inox
Disponibili anche EN 81-58

3 - 4 - 6 PANELS
Dimensions on request

Finishings:
- Anti-rust paint RAL 7032 (standard)
- RAL paint, colour on request
- Skinplate*
- Stainless steel
Fire-resistant doors also available EN 81-58*

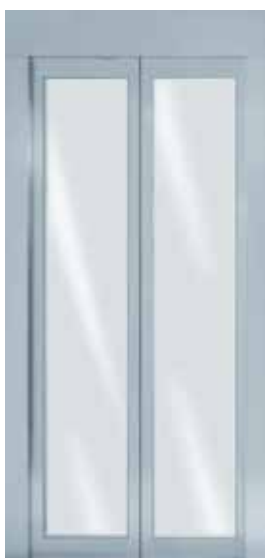

Anta vetrata
With glass panel
Photo:Wittur



Anta in vetro
Full glass panel
Photo:Wittur

ANTA VETRATA

Finiture portali e telai:
- Vernice anticorrosiva RAL 7032 (Std.) o RAL a scelta
- Inox
Vetro trasparente (Std.) o colorato (a richiesta)

ANTA IN VETRO

Finiture portali e guida inferiore:
- Vernice anticorrosiva RAL 7032 (Std.) o RAL a scelta
- Inox
Vetro trasparente (Std.) o colorato (a richiesta)

WITH GLASS PANEL

Doorway and frame finishings:
- Anti-rust paint RAL 7032 (Std.) or colours on request
- Stainless steel

Clear glass (Std.) or colours on request

FULL GLASS PANEL

Doorframe and lower guide finishings:
- Anti-rust paint RAL 7032 (Std.) or colours on request
- Stainless steel

Clear glass (standard) or colours on request

PAVIMENTI | FLOORS

GOMMA BOLLI | STUDED RUBBER



Nero | Black



Grigio | Grey

LINOLEUM | LINOLEUM

Sughero, resina, farina di legno e olio di lino sono gli ingredienti che rendono il linoleum un pavimento naturale e unico. Caratterizzato da una superficie "viva", in grado di autoriparare graffi e danneggiamenti, il linoleum è un materiale intrinsecamente robusto, ideale quindi per l'impiego in ambienti a traffico intenso. Naturalmente antibatterico, è inoltre un prodotto di facile pulizia e manutenzione.

Cork, resin, wood flour and linseed oil are the ingredients that make linoleum a natural, unique flooring. Characterised by a "live" surface, capable of self-repairing scratches and damage, linoleum is an intrinsically sturdy material and thus ideal for situations of intensive use. Naturally antibacterial, this product is also easy to clean and maintain.



LA2



LR4



LM1



LV1



810M



LGM1



LN1



LVI1

GRANITO COMPOSITO ROCKSOLID (Opzionale) | ROCKSOLID GRANIT (Optional)

Agglomerato generato dalla macinazione di graniglie di quarzo e granito.

An agglomerate generated by grinding quartz and granite chips. Infinite colour combinations can be obtained by mixing them in different percentages.



646



Sabbia



677



609

GRANITO COMPOSITO CRISTALLINO | CRISTALLINO GRANIT

Agglomerato di graniglie di vetro trasparente, temprato, ottenuto miscelando i granuli vetrosi con un legante pigmentato che ne conferisce la colorazione. La trasparenza delle graniglie dà alle lastre una suggestiva profondità.

An agglomerate of transparent glass chips, tempered, and obtained by mixing vitreous granules with a pigmented binder that gives it its colour. The transparency of the glass chips lends the slabs a suggestive illusion of depth.



2404



422

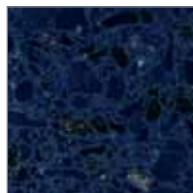

Dark blue



Cor-Ten



Blue Whale



424

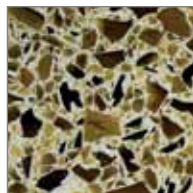

Ambra

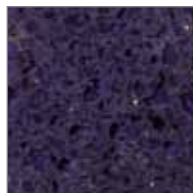

455

PAVIMENTO PERSONALIZZATO FLOOR BY CUSTOMER

Spessore max 20 mm
Thickness max 20 mm



SELE srl
Via 25 Aprile 1945, n°63
40055 Castenaso (BO)
T.+39.051.60.59.801
info@selesrl.com
www.selesrl.com



UNI EN ISO 9001:00
ALL XIII 95/16/CE NR. I 0305

OHSAS 18001
OCCUPATIONAL HEALTH AND SAFETY
ASSESSMENT SPECIFICATION



2015.09

L'azienda si riserva il diritto di modificare le informazioni tecniche ed estetiche senza preavviso
The company reserves the right to change the technical and aesthetical features without notice
